

HM-10/11/15 firmware upgrade instructions

Firmware upgrade may damage the module boot loader system, please use caution

1. Introduction

Since V508 firmware, HM-10, HM-11 provides a firmware update function through the serial port, HM-15 provides a firmware update function through the USB interface, our company website has opened a ROM download area, so that you can feel free to share the latest version of the firmware, thank you for your support of Huamao technology.

Before upgrading, you need to identify the Bluetooth module work normally, and did not establish the remote Bluetooth connectivity, and you need to have some basic circuit.

2. HM-10/11 hardware connection

HM-10/11 modules need to be connected to the computer, the upgrade process need to be completed on the computer, the module is the TTL level, computer serial port is 232 level, so can not be directly connected to the computer serial port, need to do 232 level conversion, below for your reference, and make sure the computer through the serial port to send the "AT assistant", and the module returns "OK". Factory

default baud rate is 9600, N, 8,1.

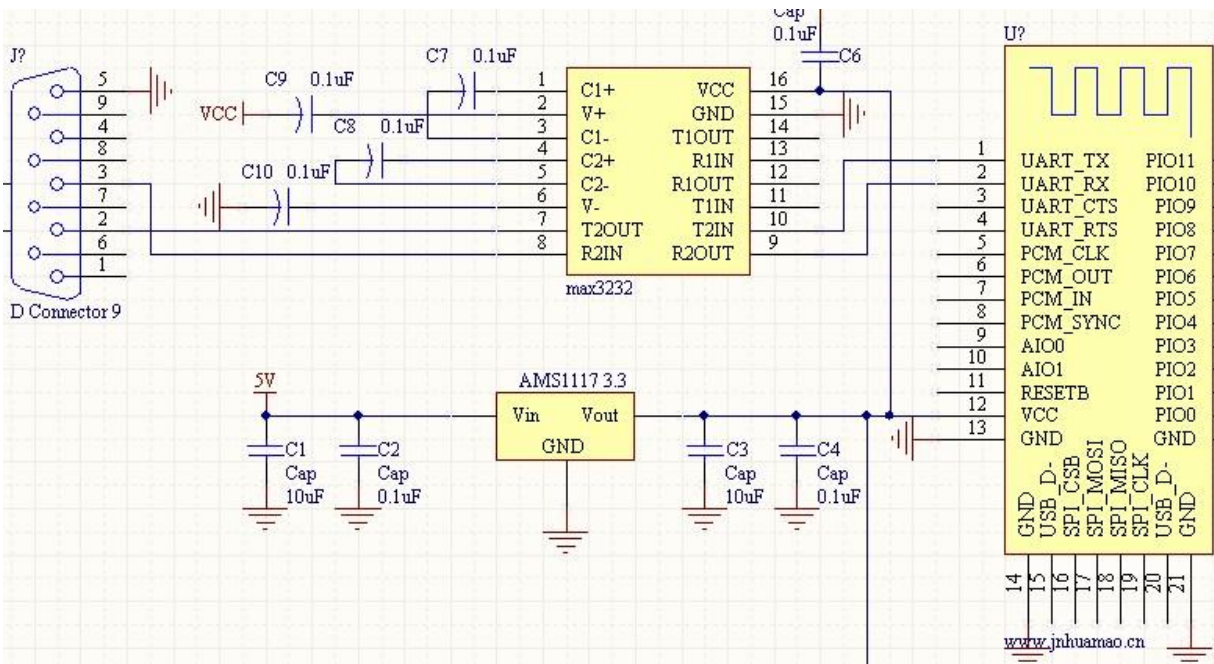

Note: please don't mistake line sequence, or else it may damage the module.

3. Let the module in the upgrading mode

When the module without establishing a remote connection, through the serial port to send the "AT+SBLUP" command use ComAssistant tool. Module will return the string "OK+SBLUP", then the module will enter the upgrade mode.



Note: this operation is not reversible, please be sure to note, after the operation is completed, if you don't want to upgrade, the module will not return to normal working mode.

4. HM-10/11 firmware update

4.1 download upgrade files from www.jnhuamao.cn download center.

Note: the CC2540 and the CC2541 version is not common, please confirm module using the chip model.

A complete upgrade package contains the following documents:

- ☆ HMSoft.bin ===== firmware file
- ☆ HMSoft.exe ===== firmware upgrade tool
- ☆ Readme.txt ===== Firmware description file

When the module is in the upgrading mode, run the HMSoft.exe, if Win7 and above, please run with administrator privileges, run this file,

please ensure that all the serial assistant has been closed. Please operate according to the following steps.

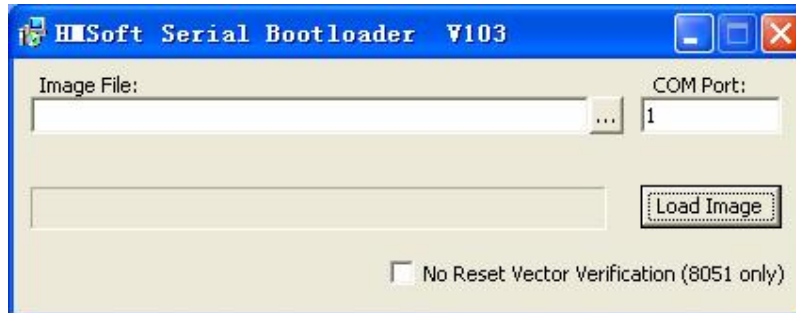

- 4.2 Input module using the serial number to the COM Port input box, please ensure that the port is not occupied
- 4.3 Click"... . "button to select the burning firmware, please select" HMSoft.bin "file.

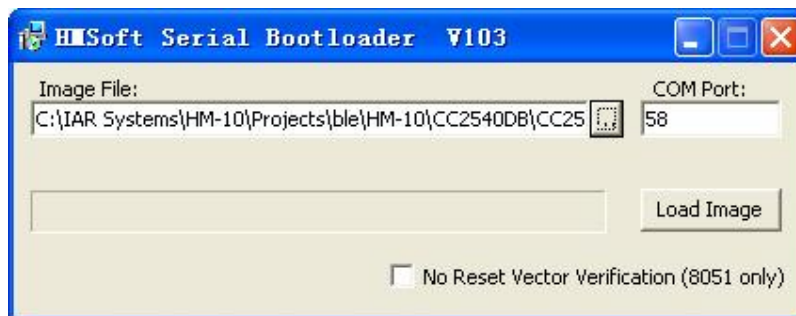

- 4.4 Click "Load Image" button, began to upgrade the firmware.

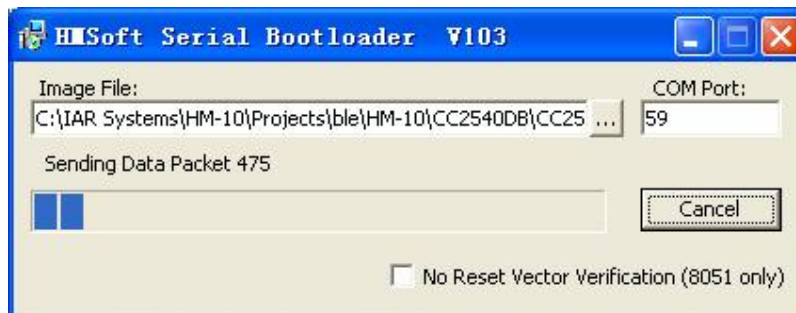

Upgrading

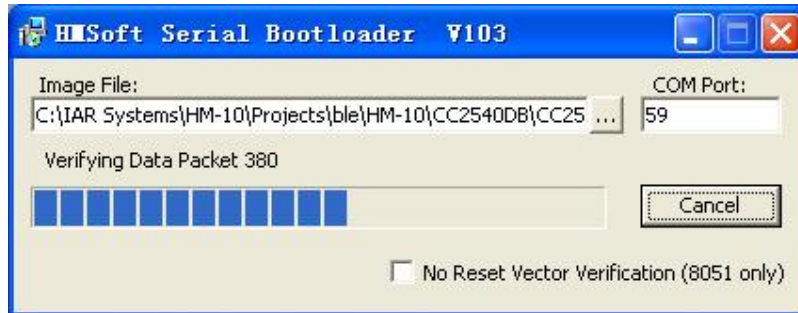

Verifying

- 4.5 Please do not proceed to other operations, for the progress of the walk, will pop up the following dialog box, which indicates the module firmware upgrade is complete, the module will automatically restart, in work mode, the upgrade is complete.

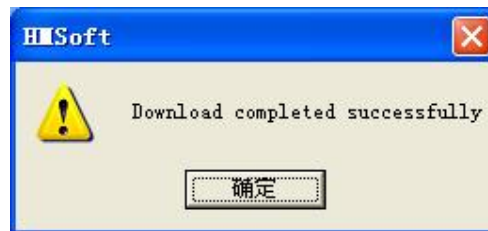

- 4.6 If not show this dialog box, please redo 4.2~4.4 steps.
5. HM-15 firmware upgrade

5.1 download upgrade files from www.jnhuamao.cn download center.

A complete upgrade package contains the following documents:

- ☆ HMSoft.bin ===== firmware file
- ☆ Readme.txt ===== Firmware description file

5.2 Upgrading method

Through the serial port assistant to send "AT+UBLUP", HM-15 returns a OK+UBLUP string, will enter the upgrade mode.

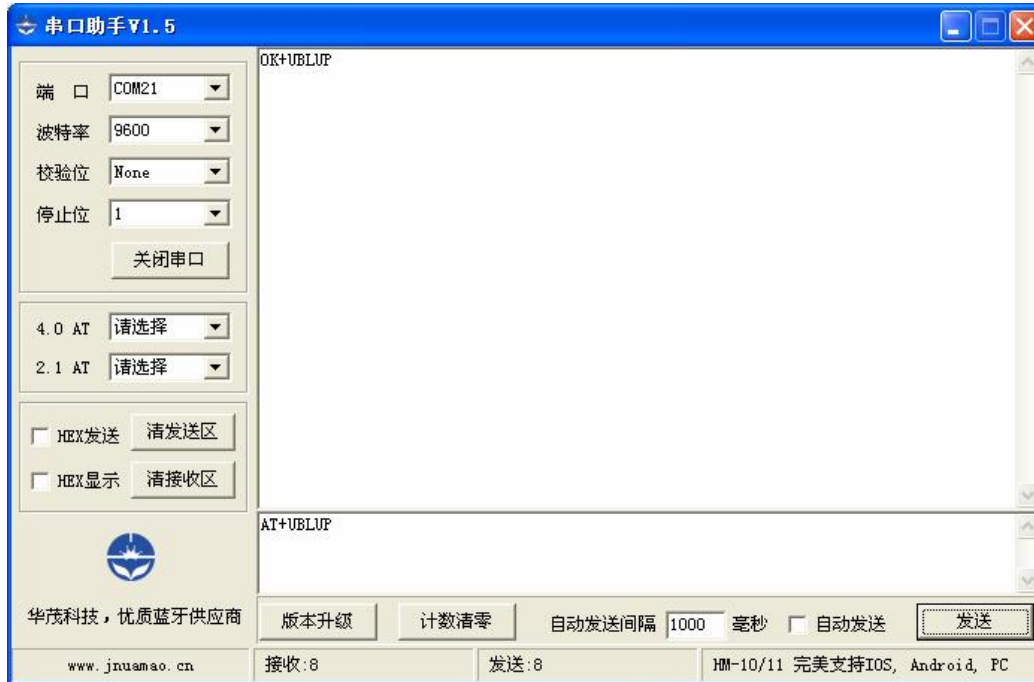

Please note, this command is not reversible, entered the upgrade mode, if you do not want to upgrade, so, you will get a 238KB super small disk.

In the upgrading mode, the computer will add a disk, double-click the disk, will appear the following display interface:

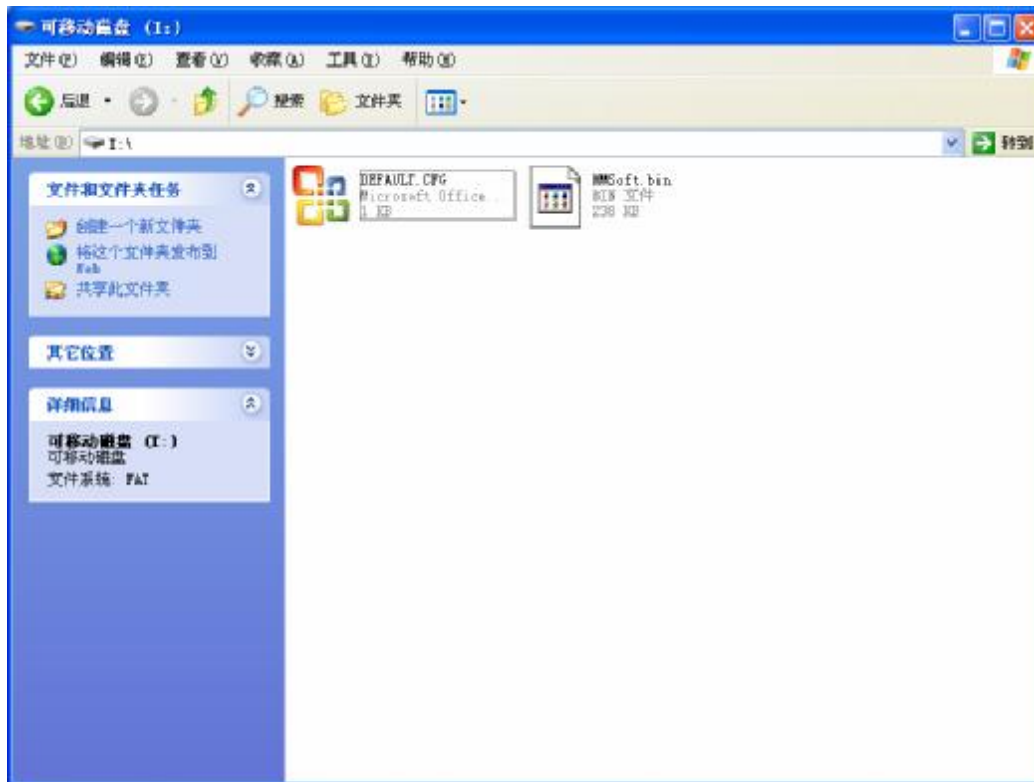

Please don't move the DEFAULT.CFG file, select the HMSoft.bin file, and delete it (can hold down Shift and then click delete menu).

After the file is deleted, the disk will temporarily disappear, please wait for the disk appears again, this time there is no HMSoft.bin file in the disk. As shown below:

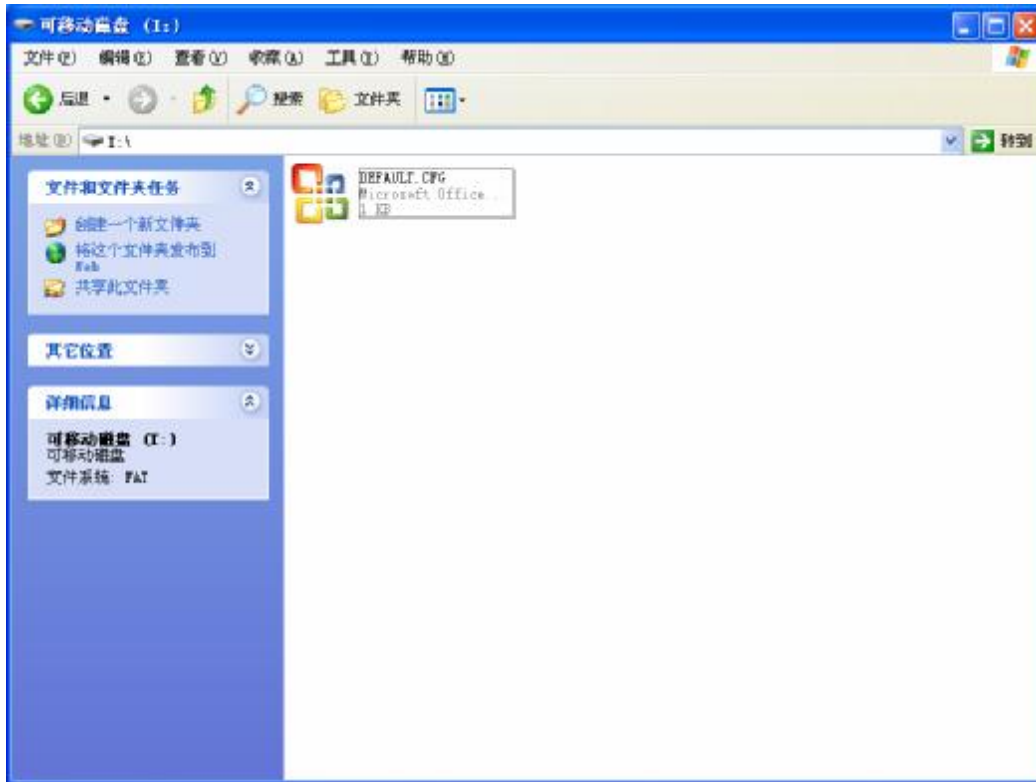

Copy HMSoft.bin file to the disk. After the completion of the copy, HM-15 will automatically restart, then enter the normal working state, the upgrade is complete.

6. Please download documents from www.jnhuamao.cn, including this document. If you have any questions, please send mail to webmaster@jnhuamao.cn.
7. My English is very bad, if you can help me to correct, will be greatly appreciated, thank you.

Jinan Huamao Technology Co,. Ltd.

2013-08

<http://www.jnhuamao.cn>